



W561
B561

SBLOCCO MOTORE PER PORTE BASCULANTI - CILINDRO A PROFILO

MOTOR RELEASE FOR OVERHEAD DOORS - EUROPEAN PROFILE CYLINDER

DISPOSITIF DE DÉVERROUILLAGE POUR PORTES DE GARAGE - CYLINDRE PROFILE EUROPÉEN

DISPOSITIVO DE DESBLOQUEO PARA PUERTAS DE GARAJE SUPERIOR - CILINDRO DE PERFIL EUROPEO



A = 70mm

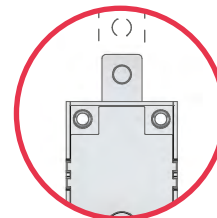
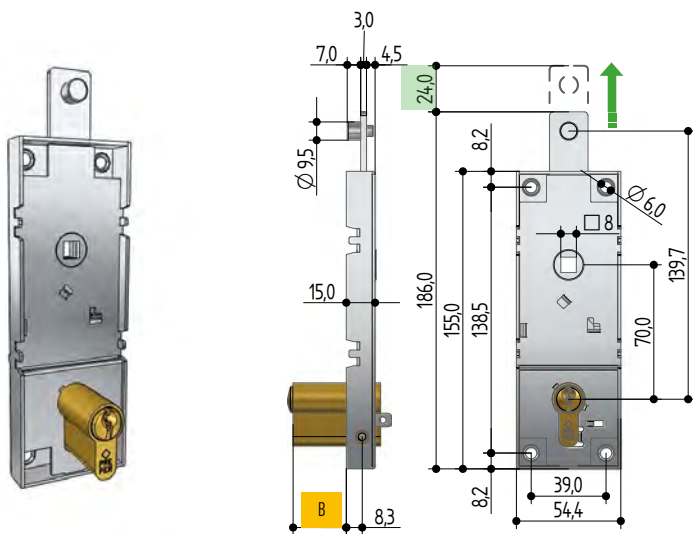

- +** Perno / foro
Pin / hole
 - 6** bolt hole - M6
 - 8** bolt hole - M8
 - A** No pin





- +** Quadro maniglia / Handle hole
Carré de poignée / Perno cuadrado
 - 7** 7 x 7 mm
 - 9** 9 x 9 mm

- Z** Senza cilindro
Without cylinder
Sans cylindre
Sin cilindro







W561

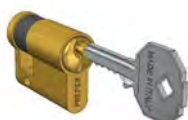

codice code code código														B mm					MIN ORD
1	2	3	4	5	6	7	8	9	10	11	12	13	14						
W	5	6	1	•	0	8	2	0	•	0	0	0	0	15,2	WEOS.2410	7300.2A00	40	1	10
W	5	6	1	•	0	8	2	2	•	0	0	0	0	22,7	WEOS.3110	7300.2B00	40	1	1

B561



codice code code código														B mm					MIN ORD
1	2	3	4	5	6	7	8	9	10	11	12	13	14						
B	5	6	1	•	0	8	1	Z		0	0	0	0	-	-	-	40	1	10
B	5	6	1	•	0	8	1	0		0	2	0	0	13,7	6A00.2210	7100.2300	40	1	10
B	5	6	1	•	0	8	1	2	•	0	2	0	0	21,7	6A00.3010	7100.2400	40	1	1
B	5	6	1	•	0	8	1	4	•	0	2	0	0	31,7	6A00.4010	7100.2400	40	1	1